

Data Sheet



Article number: 025799100168

Description: Norma Connect pipe coupling
GRIP E W2 Ø=168,3 EPDM, 16 bar

Measures

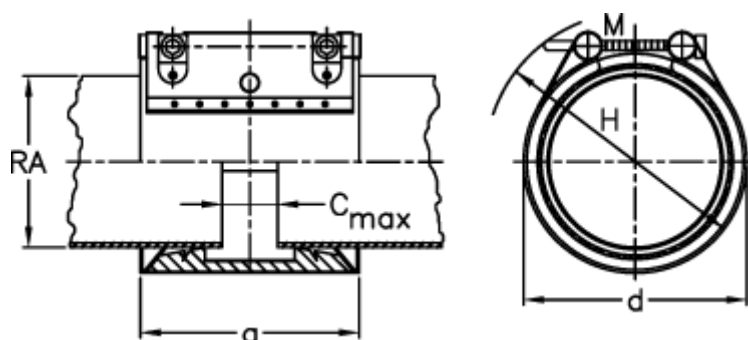

a	= 115
C max with insertion band	= 35
d	= 195
H	= 225
M (screw)	= M12
Nominal pressure (bar)	= 16
RA	= 168.3
RA min-RA max	= 166,6-170,0

Weight a piece = 2.8